

# Pressure switches 30 A/F

## Changeover switch

www.suco.de

### CE marking

SUCO pressure switches rated with an operating limit of 250 V are covered by the Low Voltage Directive 73/23/EC.

An EC Declaration of Conformity has been issued for these pressure switches and is on file at our offices. The corresponding switches bear the CE mark in our catalogue.



■ **Mounting options for wall or manifold mounting enable easy, free-maintenance installation.**

■ **Easily user-adjustable switching point.**

■ **High overpressure safety.**

■ **Socket device allows easy assembly on site.**

### Technical data

Temperature stability for diaphragm / seal materials:	NBR	-40 °C – +100 °C
	EPDM	-30 °C – +120 °C
	FKM	-5 °C – +120 °C
Switching frequency:	200 / min.	
Mechanical life expectancy:	10 <sup>6</sup> cycles (life expectancy of diaphragm pressure switches only for pressures up to max. 50 bar)	
Pressure rise rate:	≤ 1 bar/ms	
Hysteresis:	Type 0159:	approx. 10 – 30 % (not adjustable)
	Type 0161, 0162, 0175:	approx. 10 – 30 % (factory adjustable)
Vibration resistance:	10 g / 5 – 200 Hz sine-wave	
Shock resistance:	294 m/s <sup>2</sup> ; 14 ms half-sine-wave	
Body material:	Aluminium	
Degree of protection:	IP 65 socket device fitted	
Weight in grams:	Type 0159, 0161, 0162	approx. 240 g
	Type 0175:	approx. 310 g

### Electrical Values

	0159	0161/0162	
Rated operating voltage U <sub>e</sub> :	Rated operating current I <sub>e</sub>		Application category
250 Volt AC 50 / 60 Hz	2.5 Ampere	5 Ampere	AC 12
250 Volt AC 50 / 60 Hz	1 Ampere	1 Ampere	AC 14
24 Volt DC	2 / 2 Ampere	3.5 / 3.5 Ampere	DC 12 / DC 13
50 Volt DC	1 / 0.5 Ampere	2 / 1 Ampere	DC 12 / DC 13
75 Volt DC	0.75 / 0.4 Ampere	1 / 0.5 Ampere	DC 12 / DC 13
125 Volt DC	0.3 / 0.2 Ampere	0.3 / 0.2 Ampere	DC 12 / DC 13
250 Volt DC	0.3 / 0.2 Ampere	0.25 / 0.2 Ampere	DC 12 / DC 13

Rated insulation voltage U <sub>i</sub> :	300 V
Rated impulse withstand voltage U <sub>imp</sub> :	2.5 kV
Rated thermal current I <sub>the</sub> :	6 Ampere
Switching overvoltage:	< 2.5 kV
Rated frequency:	DC und 50 / 60 Hz
Short circuit current rating:	0159: To 2.5 Ampere
	0161/0162: To 6.3 Ampere
Rated short-circuit current:	< 350 Ampere
Tightening torque of terminal screws:	< 0.35 Nm
Cross section:	0.5 – 1.5 mm <sup>2</sup>

- Aluminium body
- With changeover switch and silver contacts
- Overpressure safe to 200 / 600 bar<sup>1)</sup>
- Max. voltage 250 V
- Switching point continuously adjustable by turning knurled screw while in operation.



p <sub>max.</sub> in bar	Adjustment range in bar	Tolerance at room temperature	Thread	Order number:
-----------------------------	----------------------------	----------------------------------	--------	---------------

**0159 Diaphragm pressure switches**

200 <sup>1)</sup>	0.2 – 2	± 0.2 – 0.3	G 1/4 female	0159	426	14	X	001
	0.5 – 5	± 0.2 – 0.5		0159	427	14	X	001
	1 – 10	± 0.5		0159	428	14	X	001
	2 – 20	± 1.0		0159	429	14	X	001
	5 – 50	± 3.0		0159	430	14	X	001
	10 – 100	± 3.0 – 5.0		0159	431	14	X	001

**0159 Piston pressure switches**

600 <sup>1)</sup>	10 – 100	± 3.0 – 5.0	G 1/4 female	0159	432	14	X	001
	25 – 250	± 5.0 – 7.0		0159	433	14	X	001
	40 – 400	± 5.0 – 9.0		0159	434	14	X	001

**Diaphragm / seal material – areas of application**

<b>NBR</b>	Hydraulic / machine oil, heating oil, air, nitrogen etc.	<b>1</b>
<b>EPDM</b>	Brake fluid, ozone, acetylene, hydrogen etc.	<b>2</b>
<b>FKM</b>	Hydraulic fluids (HFA, HFB, HFD), petrol/gasoline etc.	<b>3</b>

Temperature ranges of diaphragm / seal materials see page 42

<b>Order number:</b>	<b>0159 - XXX 14 - X - 001</b>
----------------------	--------------------------------

**Degree of protection IP65**

The type approval does not apply without restriction to all environmental conditions. It is the responsibility of the user to check whether the electrical connection complies with regulations other than those stated, and whether it can be used for special applications which could not be foreseen by us.

**Warning!**

When using oxygen, the relevant accident prevention regulations must be observed. In addition, we recommend that a maximum operating pressure of 10 bar is not exceeded.

Piston pressure switches are only to a limited extent suitable for use with gases. See explanation on page 9.

**With female thread**

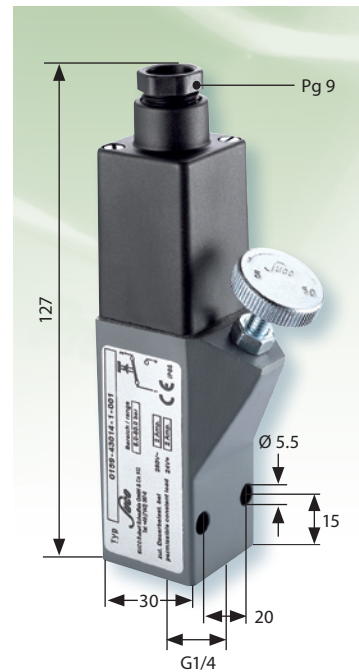

■ Our pressure switches are also available with factory pre-set switching points.

■ For further technical data and electrical values see page 42.

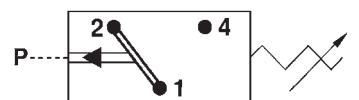

<sup>1)</sup> Static pressure, dynamic pressures should be 30 to 50% lower. These values refer to the hydraulic or pneumatic part of the pressure switch.

# 0161/0162

## Diaphragm / piston pressure switches 250 V



- Aluminium body
- With changeover switch and silver contacts
- Overpressure safe to 200 / 600 bar<sup>1)</sup>
- With socket device similar to DIN EN 175301 (DIN 43650)
- Adjustable hysteresis at works

### 0161 With female thread

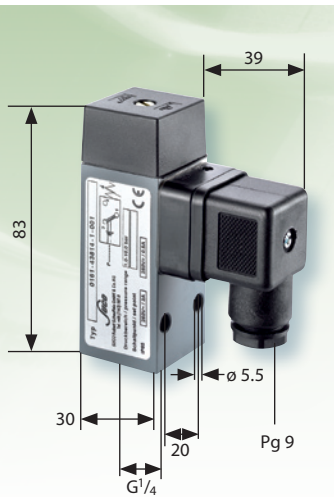

$p_{max.}$ in bar	Adjustment range in bar (tolerance at room temperature)	dim. A in mm	Female thread G 1/4	Manifold mounting
----------------------	--	-----------------	---------------------	-------------------

#### Diaphragm pressure switches

		0161				0162 <sup>2)</sup>				
200 <sup>1)</sup>	0.5 – 1 (± 0.2)	15	0161	436 14	X	001	0162	436 14	X	001
	0.5 – 5 (± 0.2–0.5)		0161	437 14	X	001	0162	437 14	X	001
	1 – 10 (± 0.5)		0161	438 14	X	001	0162	438 14	X	001
	10 – 50 (± 3.0)		0161	439 14	X	001	0162	439 14	X	001
	50 – 100 (± 3.0–5.0)		0161	440 14	X	001	0162	440 14	X	001

#### Piston pressure switches

		0161				0162 <sup>2)</sup>				
600 <sup>1)</sup>	100 – 400 (± 5.0–9.0)	19.5	0161	441 14	X	001	0162	441 14	X	001

#### Diaphragm / seal material – areas of application

<b>NBR</b>	Hydraulic / machine oil, heating oil, air, nitrogen etc.	<b>1</b>
<b>EPDM</b>	Brake fluid, ozone, acetylene, hydrogen etc.	<b>2</b>
<b>FKM</b>	Hydraulic fluids (HFA, HFB, HFD), petrol/gasoline etc.	<b>3</b>

See page 42 for temperature ranges of diaphragm materials

<b>Order number:</b>	<b>016X – XXX 14 – X – 001</b>
----------------------	--------------------------------

<sup>2)</sup> **0162:** Scope of supply includes O-ring NBR 5x1.5mm

**1** To adjust the set point, loose the locknut and turn the set screw with a screwdriver. Clock-wise screwing increases the switching pressure. After adjusting, tighten the locknut again.

### 0162 Manifold mounting

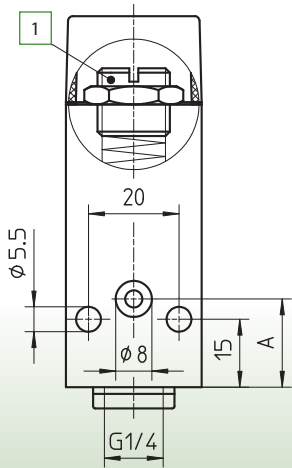

■ Our pressure switches are also available with factory pre-set switching points.

■ For further technical data and electrical values see page 42.

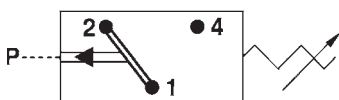

#### Degree of protection IP65

The type approval does not apply without restriction to all environmental conditions. It is the responsibility of the user to check whether the electrical connection complies with regulations other than those stated, and whether it can be used for special applications which could not be foreseen by us.

#### Warning!

When using oxygen, the relevant accident prevention regulations must be observed. In addition, we recommend that a maximum operating pressure of 10 bar is not exceeded.

Piston pressure switches are only to a limited extent suitable for use with gases. See explanation on page 9.

<sup>1)</sup> Static pressure, dynamic pressures should be 30 to 50% lower. These values refer to the hydraulic or pneumatic part of the pressure switch.

- Aluminium body
- With changeover switch and silver contacts
- Overpressure safe to 25 bar<sup>1)</sup>
- With socket device similar to DIN EN 175301 (DIN 43650)
- Adjustable hysteresis at works



p <sub>max.</sub> in bar	Adjustment range in bar	Tolerance at room temperature	Thread	Order number:
-----------------------------	----------------------------	----------------------------------	--------	---------------

**0175 Diaphragm pressure switches**

25 <sup>1)</sup>	0.1 – 1	± 0.1 – 0.2	G 1/4 female	0175 435 14 X 001
------------------	---------	-------------	--------------	-------------------

**Diaphragm material – areas of application**

<b>NBR</b>	Hydraulic / machine oil, heating oil, air, nitrogen etc.	<b>1</b>
<b>EPDM</b>	Brake fluid, ozone, acetylene, hydrogen etc.	<b>2</b>
<b>FKM</b>	Hydraulic fluids (HFA, HFB, HFD), petrol/gasoline etc.	<b>3</b>

See page 42 for temperature ranges of diaphragm materials

<b>Order number:</b>	<b>0175 - 435 14 - X - 001</b>
----------------------	--------------------------------

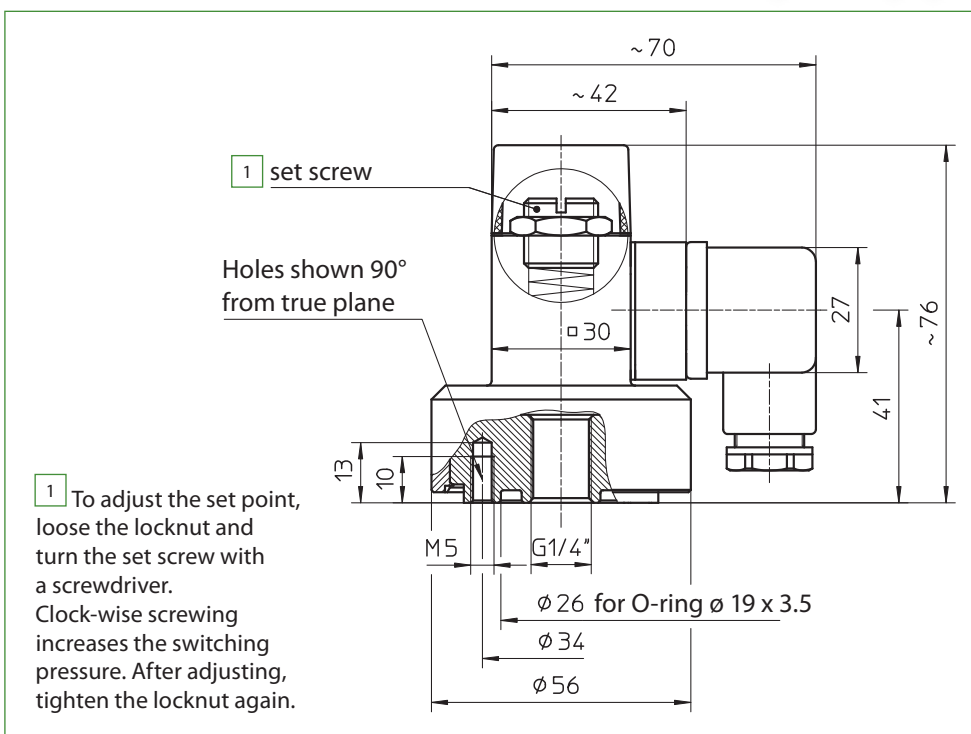

**Degree of protection IP65**

The type approval does not apply without restriction to all environmental conditions. It is the responsibility of the user to check whether the electrical connection complies with regulations other than those stated, and whether it can be used for special applications which could not be foreseen by us.

**Warning !**

When using oxygen, the relevant accident prevention regulations must be observed. In addition, we recommend that a maximum operating pressure of 10 bar is not exceeded.

**With female thread**



■ Our pressure switches are also available with factory pre-set switching points.

■ For further technical data and electrical values see page 42.

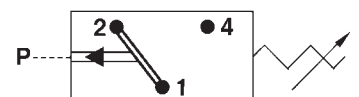

<sup>1)</sup> Static pressure, dynamic pressures should be 30 to 50% lower. These values refer to the hydraulic or pneumatic part of the pressure switch.