



CB103 CB403 CB903



General Description

A new set of controllers has been added to the CB Series to provide additional configuration flexibility. These instruments have a third contact that can be configured as an analog retransmission output, a digital contact output for RUN/STOP status or a third alarm and a contact input for SV1/SV2 or RUN/STOP functions.

These instruments are designed for heat only operation and are available in either reverse or direct control action. The Heat/Cool output or digital communications are not available on this series.

Features

- ☆ Bright, easy-to-read LED displays
- ☆ Digital contact input/output
- ☆ Analog retransmission output
- ☆ Three separate alarms
- ☆ Dual set points
- ☆ Advanced self-tuning
- ☆ IP66 (65) Waterproof/Dustproof protection

Bright, Easy-To-Read LED Displays

The CB Series features large, bright LED displays that have been designed to be easy-to-read from greater distances.

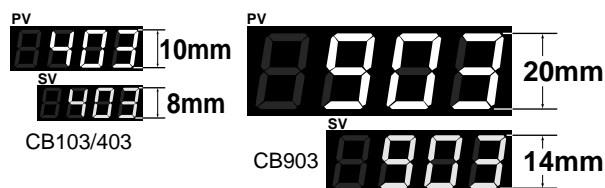

Digital Contact Input/Output (Optional)

The contact input can be selected to run either the RUN/STOP or SV1/SV2 functions. The third output can be configured to view the RUN/STOP status.

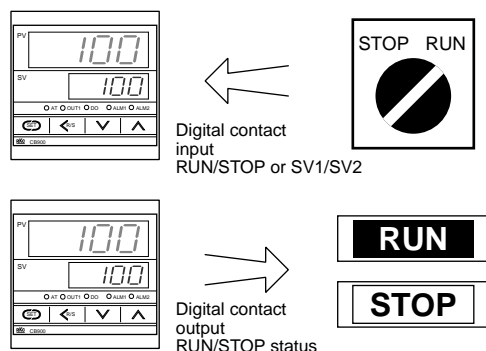

Analog Retransmission Output (Optional)

The third output can be configured as an analog retransmission output. With this function, the process value can be retransmitted as an analog current signal (4-20mA).

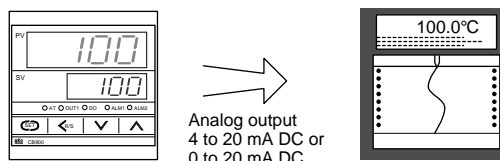

Three Separate Alarms (Optional)

This third output can be configured for a third alarm. CB103, 403, 903

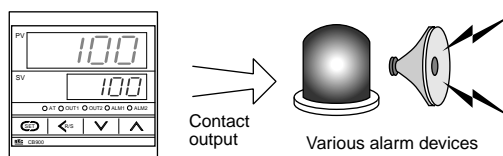

CB Series Feature Comparison

Functions	Series	CB Series CB100/400/500/700/900	CB Series CB103/403/903
Alarms (2 points) (Select two)	Temperature	☆	☆
	Heater break	☆	☆
	Control loop break	☆	☆
Aux. output (1 point) (Select one)	Temperature alarm	—	☆
	Analog output	—	☆
Contact input (Select one)	RUN/STOP status output	—	☆
	RUN/STOP switching	—	☆
Heat/Cool control	SV1/SV2 switching	—	☆
	Heat/Cool control	☆	—
Communications		☆	—
Waterproof/Dustproof		☆	☆

☆ : Selectable — : Not selectable

Features

Heater Break Alarm (Optional)

The heater break alarm (HBA) detects a fault in the heating or cooling circuit and displays actual amperage in the display on the front panel. If the measured value becomes lower than the preset value, the alarm is activated.

The HBA function requires a current detector for measuring and monitoring the current load.

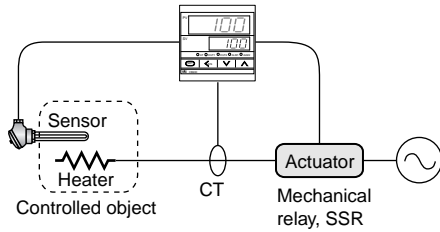

CTL-6-P-N (0 to 30A)	CTL-12-S56-10L-N (0 to 100A)
Length of lead wire : Approx. 130mm (standard)	Length of lead wire : Approx. 100mm (standard)
 φ 5.8	 φ 12

Loop Break Alarm (Optional)

The loop break alarm (LBA) monitors and protects an entire temperature control system. The LBA detects heater breaks, thermocouple or RTD failures, short circuits, or the failure of an operating device such as a mechanical or solid state relay.

When the PID computed value reaches 100% and the temperature does not respond in a set time, the loop break alarm is activated. Conversely, when the PID value reaches 0% and the temperature does not respond accordingly, the loop break alarm is turned on. In this example, the LBA uses reverse action to control heat. For cool control, the LBA action is reversed and becomes direct. LBA deadband is available to suppress the influence of external disturbances.

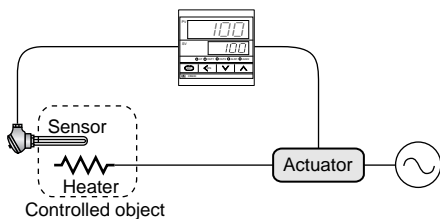

Self-Tuning Algorithm

The CB Series offers a new self-tuning feature that is initiated at start-up and when process parameters or conditions change. In these situations, the controller evaluates whether the preset PID parameters should be maintained or replaced by the latest self-tuning parameters to achieve the best control for the process. Self-tuning can be manually turned ON/OFF in the parameter setting mode. This feature is not available with the Heat/Cool control.

In addition to self-tuning, The CB Series has standard autotuning (AT) so that either function can be selected to achieve optimum process control.

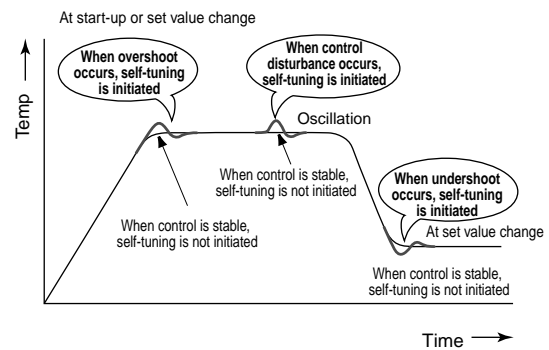

Close Horizontal Mounting

The CB Series has been designed with a unique mounting bracket that allows close horizontal mounting of multiple instruments to save valuable panel space.

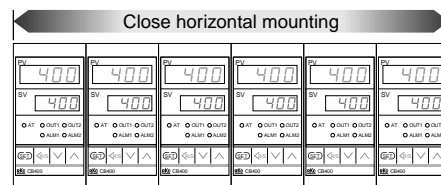

Waterproof/Dustproof (Optional)

For operation in severe environments or when washdown is required, the IP66(65) rating is available for waterproof/dustproof protection.

Specifications

Input

Input

- a) Thermocouple : K, J, R, S, B, E, T, N (JIS/IEC), PLII (NBS) W5Re/W26Re (ASTM), U, L (DIN)
- Influence of external resistance : Approx. 0.2μV/Ω
 - Input break action : Up-scale
- b) RTD : Pt100 (JIS/IEC), JPt100 (JIS)
- Influence of input lead resistance : Approx. 0.01[%/Ω] of reading
 - Maximum 10Ω per wire
 - Input break action : Up-scale
- c) DC voltage : 0 to 5V, 1 to 5V (0.0 to 100.0% (Default value))
- Input break action : Down scale
- d) DC current : 0 to 20mA, 4 to 20mA (0.0 to 100.0% (Default value))
- For DC current input, connect a 250 Ω resistor to the input terminals.
 - Input break action : Down-scale

Sampling Time

0.5 sec

PV Bias

Temperature input : -1999 (-199.9) to 9999 (999.9)°C [°F]
DC voltage, DC current : - span to +span

Performance

Measuring Accuracy

- a) Thermocouple
- ±(0.3% of reading + 1 digit) or ±2°C (4°F) whichever is larger
 - Accuracy is not guaranteed between 0 and 399°C (0 and 749°F) for type R, S and B.
 - Accuracy is not guaranteed between -199.9 and -100.0°C (-199.9 and -158.0°F) for type T and U.
- b) RTD
- ±(0.3% of reading + 1 digit) or ±0.8°C (1.6°F) whichever is larger
- c) DC voltage and DC current
- ±(0.3% of span + 1 digit)

Insulation Resistance

More than 20MΩ (500V DC) between measured terminals and ground
More than 20MΩ (500V DC) between power terminals and ground

Dielectric Strength

1000V AC for one minute between measured terminals and ground
1500V AC for one minute between power terminals and ground

Control

Control Method

- a) PID control (with autotuning and self-tuning function)
- Available for reverse and direct action. (Specify when ordering.)

Major Setting Range

Set value : Same as input range.
Proportional band : 1 to span or 0.1 to span (Temperature input)
When 0.1°C (°F) resolution, within 999.9°C (°F) or 0.1 to 100.0% of span (voltage, current input) (ON/OFF action when P=0)

- Differential gap at ON/OFF action is 2°C (°F).

Integral time : 0 to 3600sec.(P + D action when I=0)
Derivative time : 0 to 3600sec.(P + I action when D=0)
Anti-Reset Windup(ARW) : 1 to 100% of proportional band
Proportional cycle time : 1 to 100 sec.

Control Output

Relay output : Form A contact, 250V AC 3A (resistive load)
Voltage pulse output : 0/12V DC
(Load resistance : More than 600Ω)

Current output : 4 to 20mA DC
(Load resistance : Less than 600Ω)

Triac trigger output : Zero-cross method for medium capacity triac drive (less than 100A)

Triac output : Rating : 0.5A
(An ambient temperature is less than 40°C)

Waterproof/Dustproof (Optional)

- CB103 : IP66
CB403/903 : IP65
- Waterproof/dustproof protection only effective from the front in panel mounted installations.
 - Waterproof/dustproof protection is not available for close horizontal mounting installations.

Alarms (Up to 2 points) (Optional)

Temperature Alarm

- a) Type : Deviation High, Low, High/Low, Band, Process High, Low, Set value High, Low
- b) Differential gap : 2°C (°F) or 2.0°C (°F) (Temperature input)
0.2% (Voltage, current input)

Heater Break Alarm (For single phase)

- a) CT type : CTL-6-P-N(30A), CTL-12-S56-10L-N(100A)
- b) Display range : 0.0 to 100.0A
- c) Accuracy : ± 5% of input value or ± 2A (whichever is larger)
- Output from Alarm 2 terminal.

Control Loop Break Alarm (LBA)

- a) LBA time setting : 0.1 to 200.0 min.
- b) LBA deadband : 0 to 9999 °C[°F] or 100% of span (OFF by setting zero)

Alarm Output

Relay output, Form A contact 250V AC 1A (resistive load)

Auxiliary Output (Up to 1 point) (Optional)

Temperature Alarm

- a) Type : Deviation High, Low, High/Low, Band, Process High, Low
- b) Differential gap : 2°C (°F) or 2.0°C (°F) (Temperature input)
0.2% (Voltage, current input)
- c) Alarm output : Relay output, Form A contact 250V AC 3A (resistive load)

Analog Output

- a) Type : Process value, Set value, Deviation, Manipulation value
- b) Output type : DC current : 0 to 20mA, 4 to 20mA
(Load resistance : Less than 600Ω)
- c) Accuracy : ± 0.3% of span (Output ripple : ± 0.1% of span)
- d) Output resolution : More than 10bits

RUN/STOP Status Output

- a) Status : RUN : Close STOP : Open
- b) Output : Relay output, Form A contact 250V AC 3A (resistive load)

Contact Inputs (Optional)

Number of Inputs : 1 point

Contact Input Type

- a) RUN/STOP switching (OPEN : STOP, CLOSE : RUN)
- b) STEP function (OPEN : SV1, CLOSE : SV2)

Input Rating

Non-voltage contact input (OPEN : 500kΩ or more, CLOSE : 10Ω or less)

General Specifications

Supply Voltage

- a) 85 to 264V AC (Including supply voltage variation)
[Rating : 100 to 240V AC] (50/60Hz common)
- b) 21.6 to 26.4V AC (Including supply voltage variation)
[Rating : 24V AC] (50/60Hz common)
- c) 21.6 to 26.4V DC (Ripple rate 10% p-p or less) [Rating : 24V DC]

Power Consumption

Less than 10VA for standard AC type
Less than 5VA for 24V AC type
Less than 160mA for 24V DC type

Power Failure Effect

A power failure of 20ms or less will not affect the control action.
If power failure of more than 20ms occurs, controller will restart.

Operating Environments : 0 to 50°C [32 to 122°F] , 45 to 85% RH

Memory Backup : Backed up by non-volatile memory.

Net Weight

CB103 : Approx. 170g, CB403 : Approx. 250g, CB903 : Approx. 340g

External Dimensions (W x H x D)

CB103 : 48 x 48 x 100mm, CB403 : 48 x 96 x 100mm
CB903 : 96 x 96 x 100mm

Compliance with Standards

- CE Mark
- UL Recognized
- CSA Certified



- Triac trigger output type and triac output are not CE Mark, UL Recognized or CSA Certified.

Digital Temperature Controller CB103/403/903

Model and Suffix Code

Specifications	Model and Suffix Code									
Size	CB103 (1/16 DIN size) <input type="checkbox"/> <input type="checkbox"/> <input type="checkbox"/> <input type="checkbox"/> <input type="checkbox"/> * <input type="checkbox"/> <input type="checkbox"/> <input type="checkbox"/> <input type="checkbox"/> <input type="checkbox"/> / <input type="checkbox"/> / Y CB403 (1/8 DIN size) CB903 (1/4 DIN size)									
Control method	PID control with AT (reverse action) F PID control with AT (direct action) D									
Input type	See Range and Input Code Table <input type="checkbox"/>									
Range	See Range and Input Code Table <input type="checkbox"/>									
Control output	Relay output Voltage pulse DC current : 4 to 20mA Triac trigger Triac output					M V 8 G T				
Alarm 1	No alarm See Alarm Code Table					N <input type="checkbox"/>				
Alarm 2	No alarm See Alarm Code Table					N <input type="checkbox"/>				
Auxiliary output ¹	No auxiliary output See Alarm Code Table (Code : A to L) RUN/STOP status output Analog output : 0 to 20mA Analog output : 4 to 20mA					N <input type="checkbox"/> Y 7 8				
Contact input (DI)	Not supplied STEP function (Select SV1/SV2) RUN/STOP transfer					N 1 2				
Waterproof/Dustproof	Not supplied Waterproof/Dustproof protection					N 1				
Body color	Black White					A N				
Instrument version	Version symbol Y									

¹ The auxiliary output is not available for the triac trigger output.

Range and Input Code Table

Thermocouple (Field-programmable)

Input	Code	Range
K	K 01	0 - 200°C
	K 02	0 - 400°C
	K 03	0 - 600°C
	K 04	0 - 800°C
	K 05	0 - 1000°C
	K 06	0 - 1200°C
	K 07	0 - 1372°C
	K 13	0 - 100°C
	K 14	0 - 300°C
	K 20	0 - 500°C
	K A1	0 - 800°F
	K A2	0 - 1600°F
	K A3	0 - 2502°F
	K A9	20 - 70°F
J	J 01	0 - 200°C
	J 02	0 - 400°C
	J 03	0 - 600°C
	J 04	0 - 800°C
	J 05	0 - 1000°C
	J 06	0 - 1200°C
	J A1	0 - 800°F
J A2	0 - 1600°F	
J A3	0 - 2192°F	
J A6	0 - 400°F	
R ¹	R 01	0 - 1600°C
	R 02	0 - 1769°C
	R 04	0 - 1350°C
	R A1	0 - 3200°F
	R A2	0 - 3216°F
S ¹	S 01	0 - 1600°C
	S 02	0 - 1769°C
	S A1	0 - 3200°F
S A2	0 - 3216°F	
B ¹	B 01	400 - 1800°C
	B 02	0 - 1820°C
	B A1	800 - 3200°F
B A2	0 - 3308°F	

Input	Code	Range
E	E 01	0 - 800°C
	E 02	0 - 1000°C
	E A1	0 - 1600°F
N	E A2	0 - 1832°F
	N 01	0 - 1200°C
	N 02	0 - 1300°C
T ²	N A1	0 - 2300°F
	N A2	0 - 2372°F
	T 01	-199.9 - 400.0°C
	T 02	-199.9 - 100.0°C
	T 03	-100.0 - 200.0°C
	T 04	0.0 - 350.0°C
	T A1	-199.9 - 752.0°F
	T A2	-100.0 - 200.0°F
	T A3	-100.0 - 400.0°F
	T A4	0.0 - 450.0°F
W5Re W26Re	T A5	0.0 - 752.0°F
	W 01	0 - 2000°C
PL II	W 02	0 - 2320°C
	W A1	0 - 4000°F
	A 01	0 - 1300°C
U ²	A 02	0 - 1390°C
	A 03	0 - 1200°C
	A A1	0 - 2400°F
	A A2	0 - 2534°F
	U 01	-199.9 - 600.0°C
	U 02	-199.9 - 100.0°C
	U 03	0.0 - 400.0°C
L	U A1	-199.9 - 999.9°F
	U A2	-100.0 - 200.0°F
	U A3	0.0 - 999.9°F
L	L 01	0 - 400°C
	L 02	0 - 800°C
	L A1	0 - 800°F
L A2	0 - 1600°F	

RTD (Field-programmable)

Input	Code	Range
Pt100	D 01	-199.9 - 649.0°C
	D 02	-199.9 - 200.0°C
	D 03	-100.0 - 50.0°C
	D 04	-100.0 - 100.0°C
	D 05	-100.0 - 100.0°C
	D 06	0.0 - 50.0°C
	D 07	0.0 - 100.0°C
	D 08	0.0 - 200.0°C
	D 09	0.0 - 300.0°C
	D 10	0.0 - 500.0°C
	D A1	-199.9 - 999.9°F
	D A2	-199.9 - 400.0°F
	D A3	-199.9 - 200.0°F
	D A4	-199.9 - 100.0°F
	D A5	-100.0 - 300.0°F
	D A6	0.0 - 100.0°F
	D A7	0.0 - 200.0°F
	D A8	0.0 - 400.0°F
	D A9	0.0 - 500.0°F
JPt100	P 01	-199.9 - 649.0°C
	P 02	-199.9 - 200.0°C
	P 03	-100.0 - 50.0°C
	P 04	-100.0 - 100.0°C
	P 05	-100.0 - 200.0°C
	P 06	0.0 - 50.0°C
	P 07	0.0 - 100.0°C
	P 08	0.0 - 200.0°C
	P 09	0.0 - 300.0°C
	P 10	0.0 - 500.0°C

Voltage and Current ³ (Field-programmable)

Input	Code	Range
0-5V DC	4 01	0.0 - 100.0
1-5V DC	6 01	0.0 - 100.0
0-20mA DC	7 01	0.0 - 100.0
4-20mA DC	8 01	0.0 - 100.0

¹ Type R, S and B input : Accuracy is not guaranteed between 0 to 399°C (0 to 799°F)

² Type T and U input : Accuracy is not guaranteed between -199.9 to -100.0°C (-199.9 to -158.0°F)

³ DC current input : A 250 Ω resistor is externally connected at the input terminals.

Alarm Code Table

Code	Type
A	Deviation High
B	Deviation Low
C	Deviation High/Low
D	Band Alarm
E	Deviation High with Alarm Hold
F	Deviation Low with Alarm Hold
G	Deviation High/Low with Alarm Hold
H	Process High

Code	Type
J	Process Low
K	Process High with Alarm Hold
L	Process Low with Alarm Hold
R 1	Loop break alarm (LBA)
P 2	Heater break alarm (CTL-6-P-N [30A])
S 2	Heater break alarm (CTL-12-S56-10L-N [100A])
V	Set value High
W	Set value Low

¹ Loop break alarm is not available for Heat/Cool PID control type.

² Heater break alarm can only be assigned to Alarm 2. Heater break alarm is not available for current output.

Supply Voltage

100 - 240V AC	24V AC	24V DC
---------------	--------	--------

Accessory

Current transformer for heater break alarm

CTL-6P-N (0 - 30A)

CTL-12-S56-10L-N (0 - 100A)

Shunt resistor for DC current input

KD100-55

Terminal cover

KCA100-517 (CB103) KCA400-513 (CB403)

KCA900-58 (CB903)



External Dimensions

Units : mm

•External dimensions

CB903

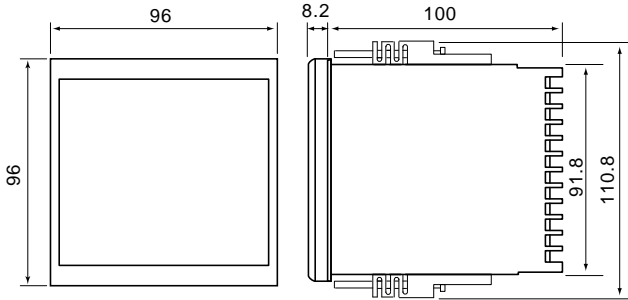

•Panel cutouts

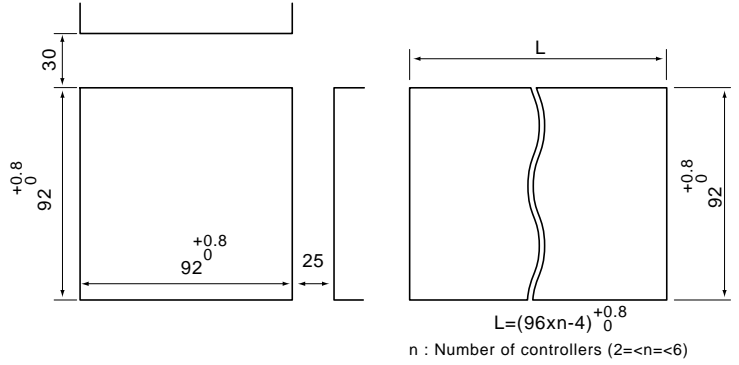

CB403

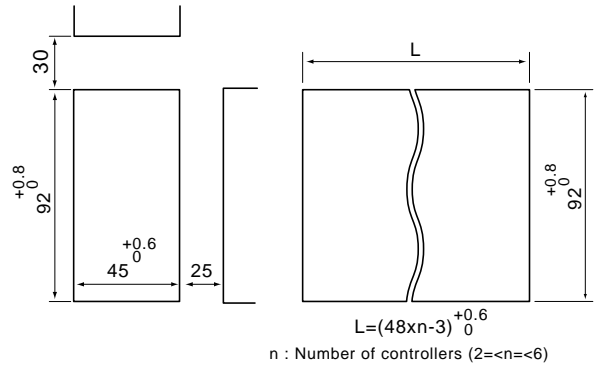
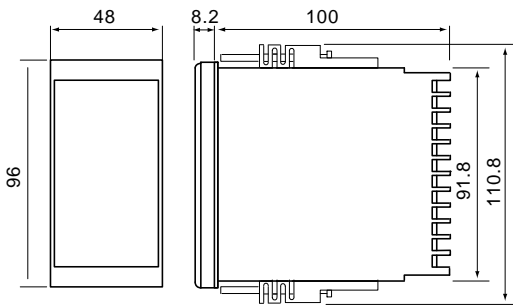

CB103

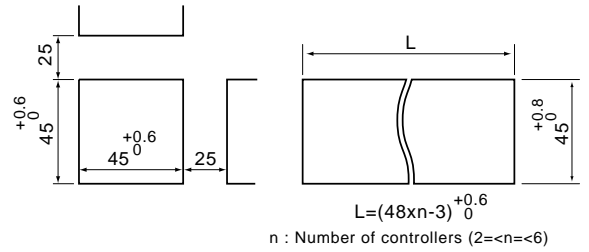
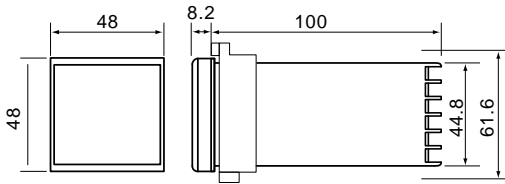

Digital Temperature Controller CB103/403/903



Rear Terminals

CB903

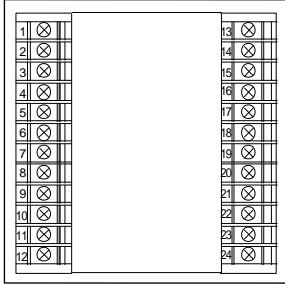

CB403

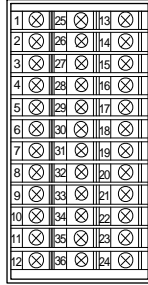

No.	Description
1	AC 100 to 240V AC 24V DC+ 24V -
2	
3	(1) NO (2) T2
4	
5	(1) NO (2) T1 (3) SSR
6	
7	Alarm 2 NO
8	Alarm 1 NO
9	
10	A
11	B
12	(1) (2) (3)

No.	Description
13	-
14	DI
15	+
16	
17	
18	
19	
20	
21	
22	
23	CT input for heater break alarm
24	

CB103

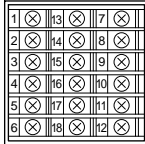

No.	Description
1	AC 100 to 240V AC 24V DC+ 24V -
2	
3	(1) NO (2) T2
4	
5	(1) NO (2) T1 (3) SSR
6	
7	Alarm 2 NO
8	Alarm 1 NO
9	
10	A
11	B
12	(1) (2) (3)

No.	Description
13	-
14	DI
15	+
16	
17	CT input for heater break alarm
18	